

**REPAIRS SHOULD BE PERFORMED BY A QUALIFIED TECHNICIAN
 IF YOU ARE NOT QUALIFIED TO PERFORM REPAIRS ON THIS PRODUCT, EWC PROVIDES A
 REFURBISHMENT PROGRAM. EWC STRONGLY RECOMMENDS FACTORY REFURBISHMENT.
 CALL EWC CONTROLS FOR MORE INFORMATION 800-446-3110**

IMPORTANT: Read these instructions thoroughly! Before proceeding check the replacement part number and voltage rating on the lower left hand corner of the new printed circuit board to verify it matches that information on the old circuit board that is being replaced.

To replace the Printed Circuit Board in the “S” series steam humidifier, you must ***unplug and shut down your steam humidifier and allow it to cool.*** Pull straight up on the Green low voltage terminal block to disconnect it from the unit. The water tank must be drained, the water supply, drain lines and electrical wiring must be disconnected and the unit removed from the duct. ***Place the unit on a flat working surface.***

Contents:

- 1 120V or 240V Circuit Board
- 1 Replacement Instructions
- 2 Cable Ties
- 1 Front Cover
- 1 Phenolic Mounting Bar
- 4 Phillips Head Screws # 4.40
- 2 Phillips Head Screws # 8-32
- 1 System Terminal Block w/ Jumper

1. Unplug the drain valve assembly from the side of the front cover. Snip the plastic wire tie that secures the drain valve to the main power cord.
2. Use an adjustable wrench at the **brass “T” adapter** to unscrew the entire drain valve assembly. **DO NOT** use the drain valve itself as leverage when removing or re-installing the drain valve assembly. Doing so will damage the drain valve assembly and void the warranty.
3. Using a phillips head screwdriver loosen the four screws that securing the front cover and remove the front cover.

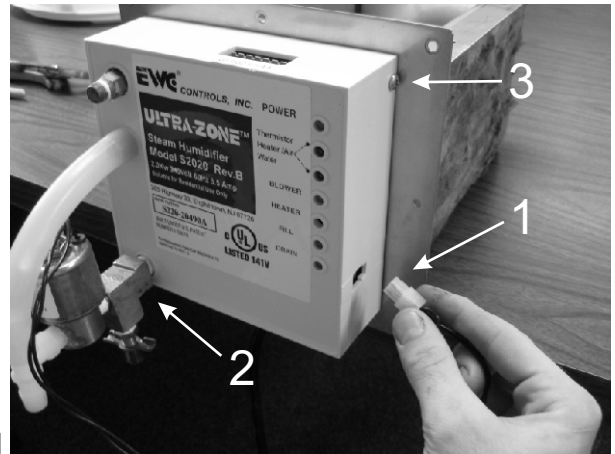
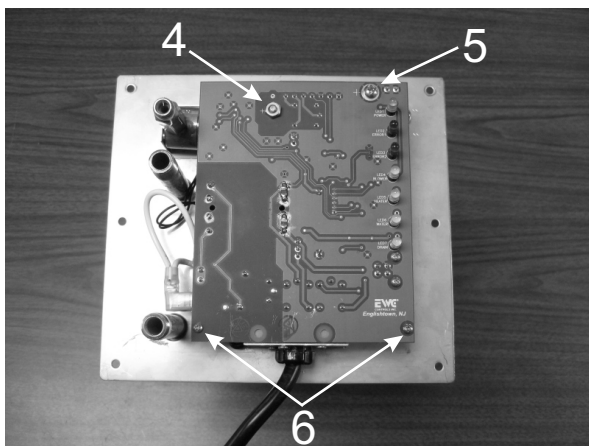

Figure 1



4. Use an 11/32” nut driver to loosen and remove the hex nut which secures the water level probe to the printed circuit board.
 5. Remove the ground screw at the upper right hand corner of the printed circuit board.
 6. Remove the two small phillips head screws at the bottom corners of the printed circuit board.
- The printed circuit board can now be laid flat.

Figure 2

NOTE: In the next few steps you will be disconnecting spade connectors from the old printed circuit board. Loose spade connectors can overheat and damage the wires. It is very important that you do not loosen the spade connectors by rocking them back and forth while trying to remove them. If for any reason the spade connectors have become loose, use pliers to re-tighten them before reinstalling the new circuit board.

7. Locate the wires from the Thermistor Probe and trace them to where they connect to the printed circuit board. Pull the connector off the board from the J2 pins.
8. Locate the wires from the Water Fill Valve and trace them to where they connect on the printed circuit board. Pull the connector off the board from the J3 pins.
9. Locate the two black wires connected to the large relay on the printed circuit board. Use needle nose pliers and pull them off the relay "COM" and "NO" terminals.
10. Locate the single white wire where it connects to the circuit boards "NEUT" terminal and disconnect it using needle nose pliers.
11. Remove the green ground wire last from the printed circuit board. The printed circuit board should now be loose in your hands. Set it down on the work surface out of the way.

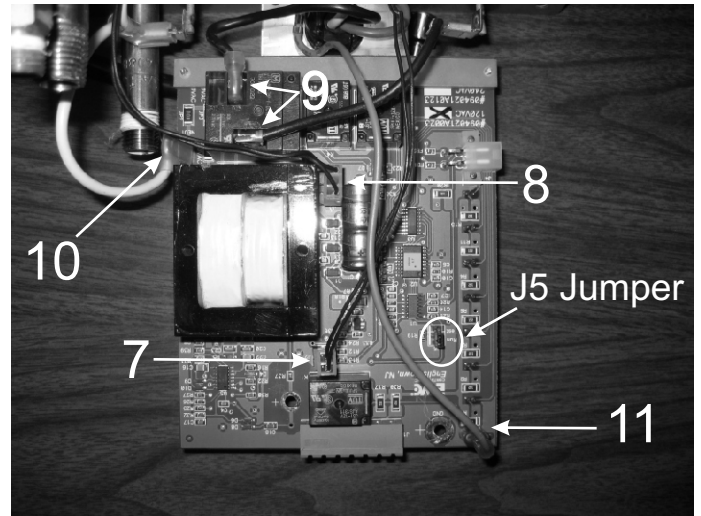

Figure 3

You are now ready to install your new printed circuit board.

NOTE: Your new printed circuit board may include a new 7 pin green terminal block and a new Front Cover. If the defective circuit board had a 5 pin green terminal block, you must use the new 7 pin terminal block and the new front cover! Otherwise reuse the existing 7 pin terminal block and front cover.

Make sure the J5 jumper (See Figure 3) is set to the RUN position not TEST or simply remove the connector and the circuit board will default to "RUN". Set the new printed circuit board in position and reverse the process. Be careful not to damage it!

NOTE: You will now reconnect the spade connectors to the new printed circuit board. Loose spade connectors can overheat and damage the wires. If for any reason the spade connectors have become loose, use pliers to re-tighten them before reinstalling the new circuit board. Do not allow line and load wires to cross over each other. Doing so will void your warranty.

1. Push the ground wire terminal back onto the connector on the upper right hand corner of the board.
2. Push the white wire back onto the "NEUT" terminal.
3. Push the black wire lead from the power cord on to the "NO" terminal on the large relay. Push the other black wire lead from the heating element back onto the "COM" terminal on the large relay.
NOTE: This may be reversed from the old circuit board.
4. Push the connector from the water fill valve back on to the J3 connector pins.
5. Push the connector from the thermistor probe back onto the J2 pins.

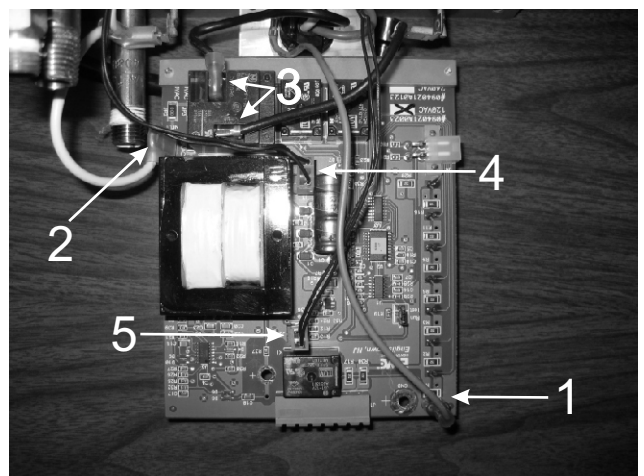

Figure 4

NOTE: If your old circuit board was attached to the steamer tank with an insulating bar between the tank and the circuit board, advance to the next page for further instructions. Otherwise continue with the installation.

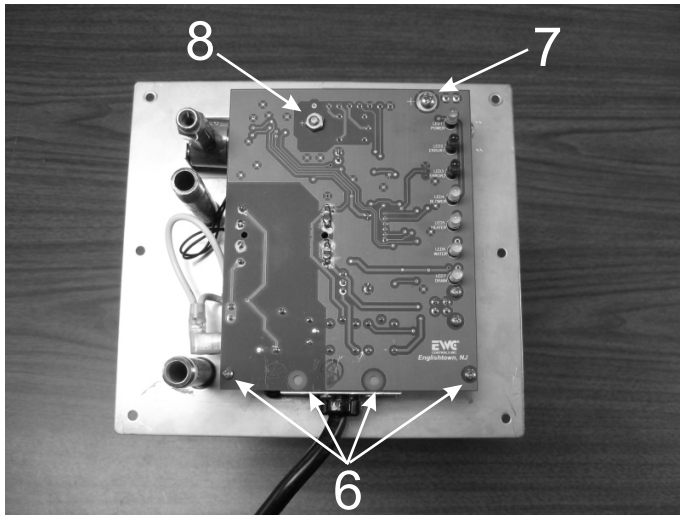

Figure 5

Make sure that no wires are pinched between the transformer and the front plate. Re-route the wires as necessary. Review your work for accuracy.

6. Tighten the two small phillips head screws at the bottom of the printed circuit board.
7. Tighten the ground screw at the upper right hand corner of the board.
8. Position the water level probe back into the hole on the printed circuit board. Re-install the hex nut and tighten down firmly against the other hex nut, while holding the water level probe leg straight down towards the bottom of the tank. Loosen the hex nut and readjust if necessary.

9. Now you can re-install the front cover. Make sure to line up with the LED's on the printed circuit board. Do not crush them when pushing the front cover back on. You may have to loosen the front cover screws a bit more. Press the front cover back on all the way and tighten the four front cover screws.
10. Apply Teflon tape to the threads of the "T" adapter on the automatic drain valve. Screw the entire drain valve assembly back onto the drain fitting and tighten with an adjustable wrench. **DO NOT** use the solenoid valve itself as leverage to turn and tighten the assembly. Doing so will damage the valve. Tighten and position the drain assembly to the original position.
11. Plug the drain connector back in on the side of the front cover until it snaps into place. Secure the drain valve wires with the short cable tie.

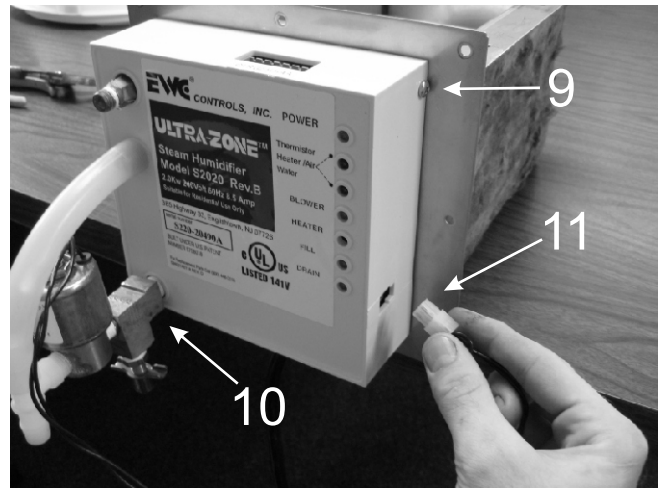

Figure 6

Review the entire project to be sure that nothing has been overlooked.

Now insert the unit back into the duct and secure it.

Re-connect the water, electrical and drain connections. Open the water source valve and plug the steam humidifier into it's electrical outlet. Make sure the humidistat is calling for humidity. Observe the operation of the unit and make sure there are no water leaks. Review the original owner's manual for operational sequence and other helpful information. If you have any questions call the technical support hotline @ 1-800-446-3110.

If your steamer has a **90° flange** on the circuit board mounting plate you will screw the circuit board directly into the plate as shown in Figure 7.

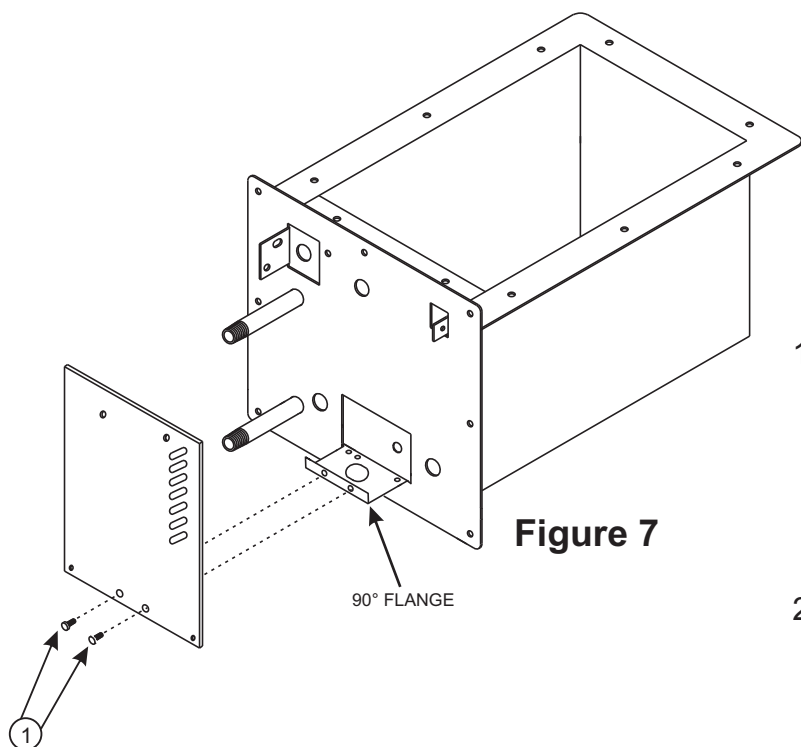

1. Using the two small phillips head screws provided, fasten the new printed circuit board to the 90° Flange on the humidifier tank. **Make sure that no wires are pinches between the transformer and the front plate. Re-route the wires as necessary. Review your work for accuracy.**
2. You can now proceed with the instructions from there you left off on the previous page.

If your steamer ***DOES NOT*** have a **90° flange** on the circuit board mounting plate you will use an **insulating bar** between the circuit board and the plate as shown in Figure 8.

1. Using the two small phillips head screws provided, fasten the new insulating bar to the new circuit board as shown in step 1 of the illustration below.
2. You can now fasten the circuit board to the tank using the provided phillips head screws as shown in step 2 of the illustration below. **Make sure that no wires are pinches between the transformer and the front plate. Re-route the wires as necessary. Review your work for accuracy.**
3. You can now proceed with the instructions from where you left off on the previous page.

